

# 13. ENGINE ELECTRICAL SYSTEM

## ● LHD model

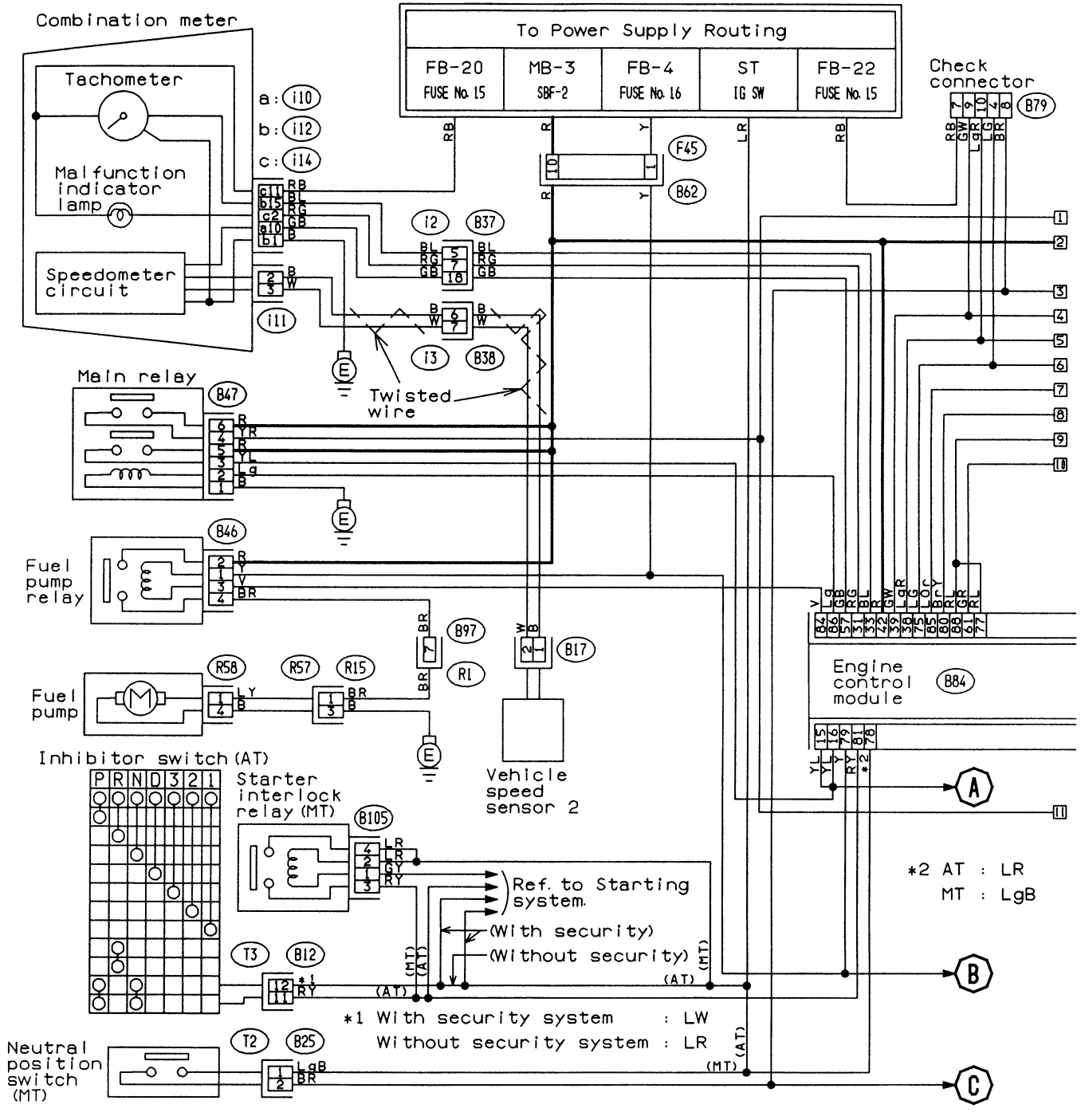

To Power Supply Routing				
FB-20	MB-3	FB-4	ST	FB-22
FUSE No. 15	SBF-2	FUSE No. 16	IG SW	FUSE No. 15

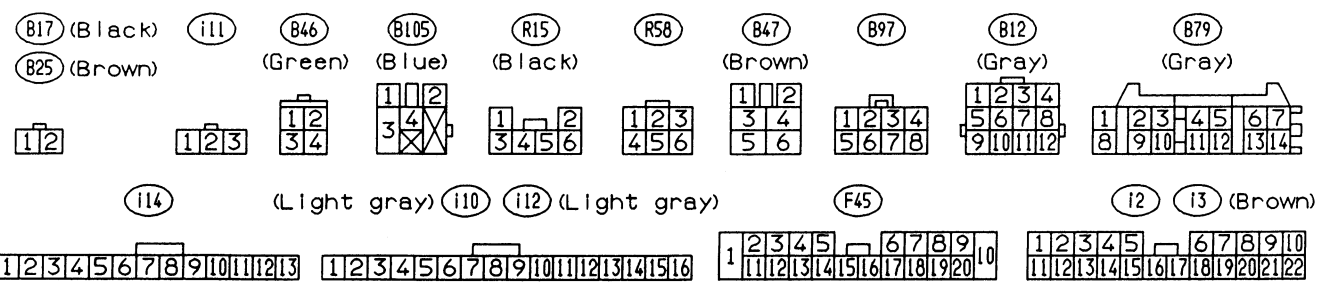

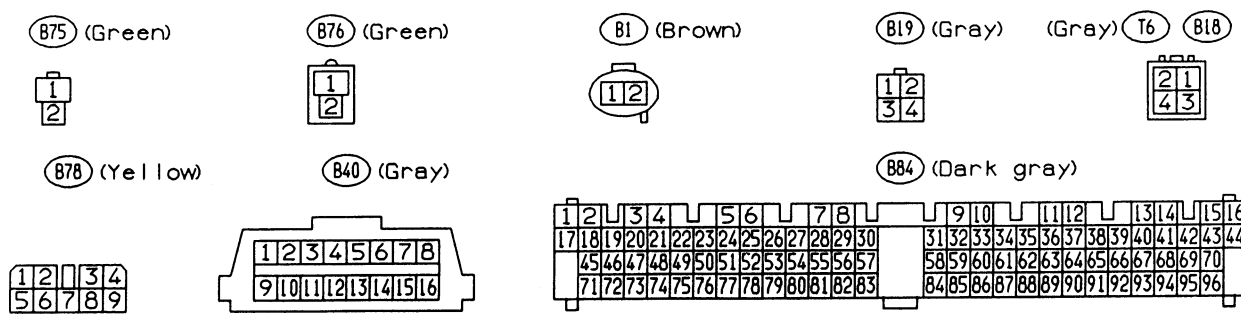
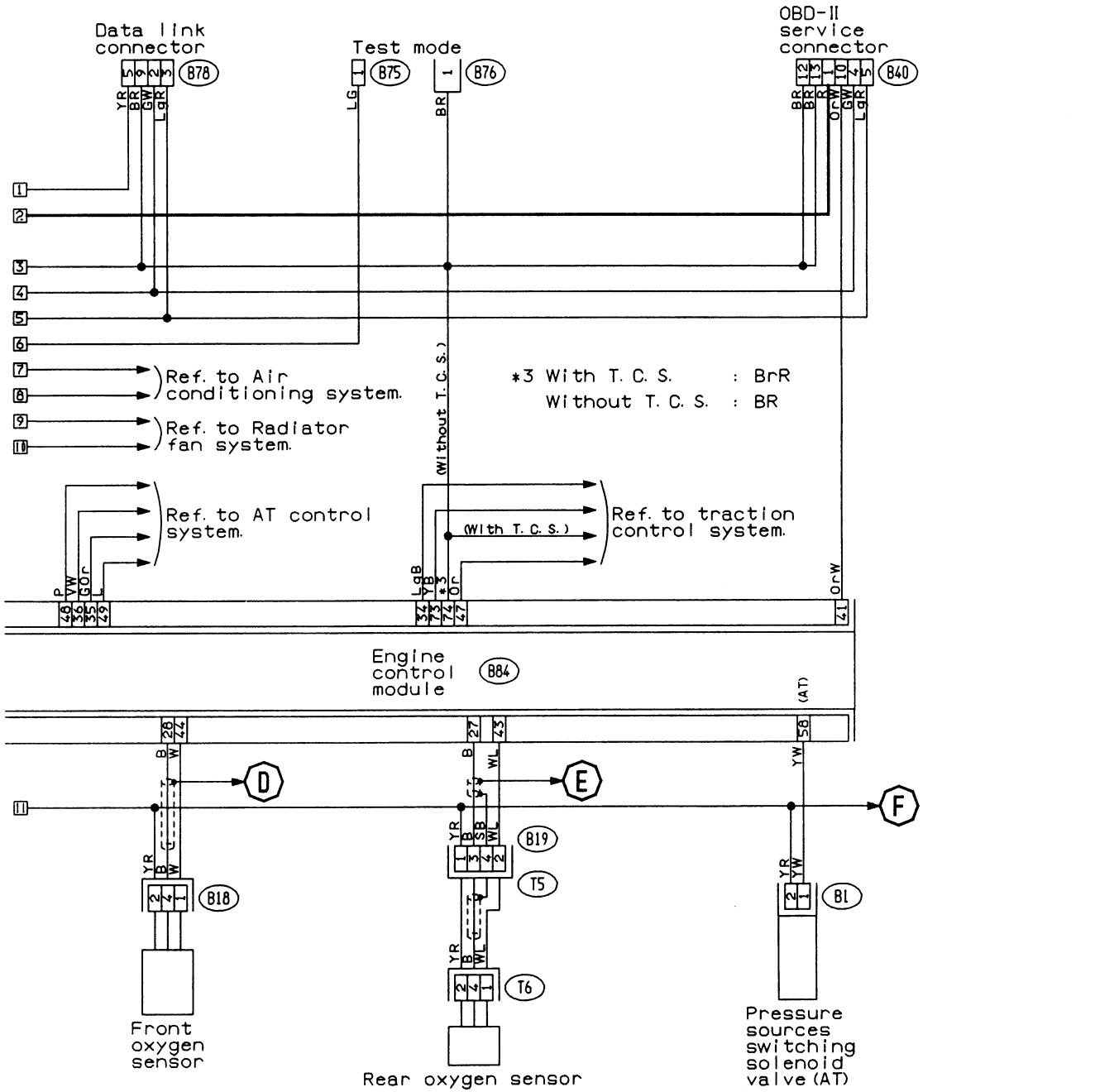

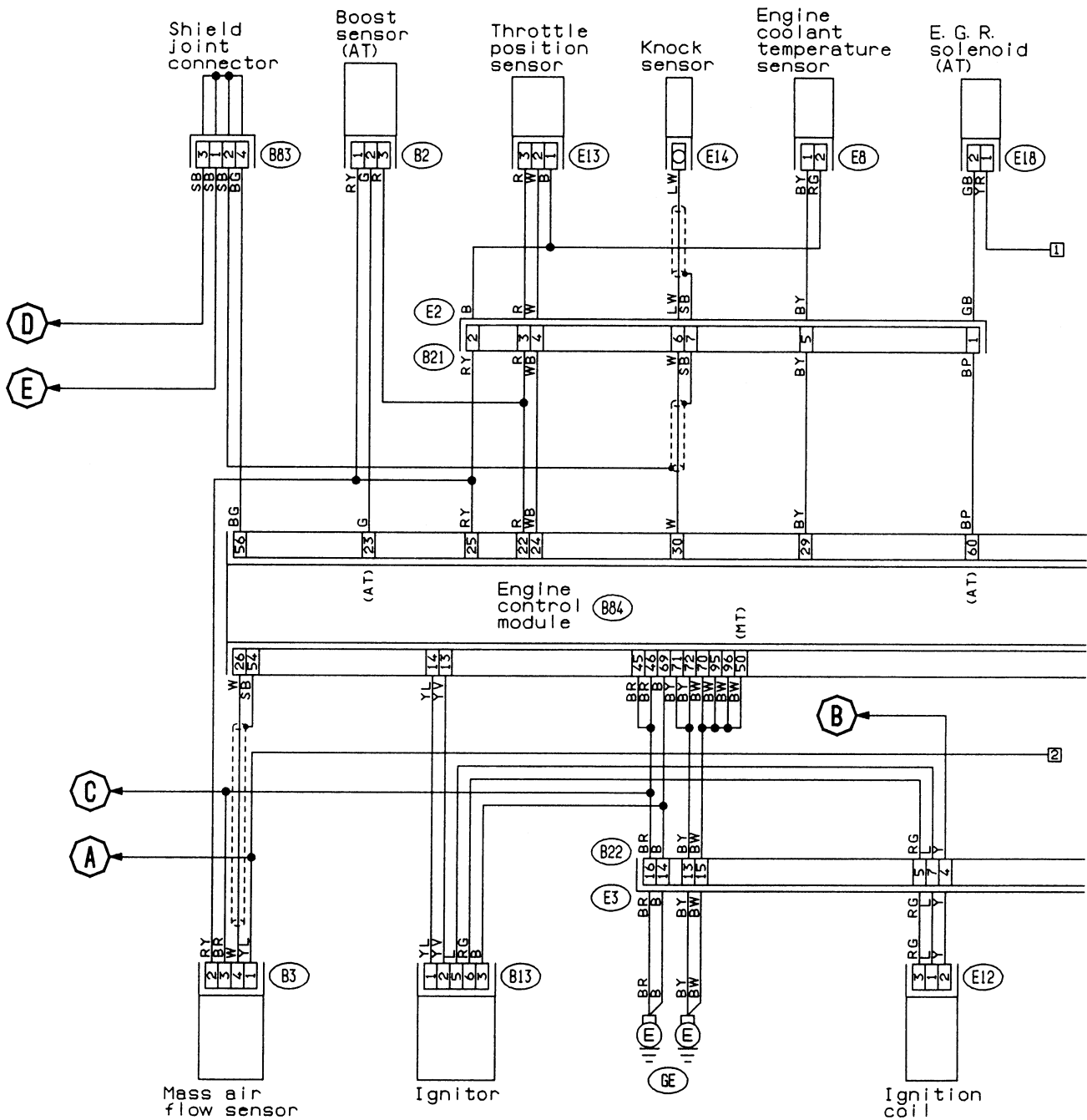

(Brown) (E18) (E8) (Brown) (Black) (B2) (E13) (Brown)

(E12) (Gray)

(B83)

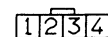

(B3) (Gray)

(B13) (Gray)

(B21) (Light gray)

(B22) (Light gray)

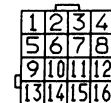
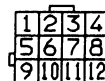
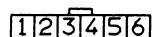
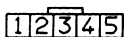

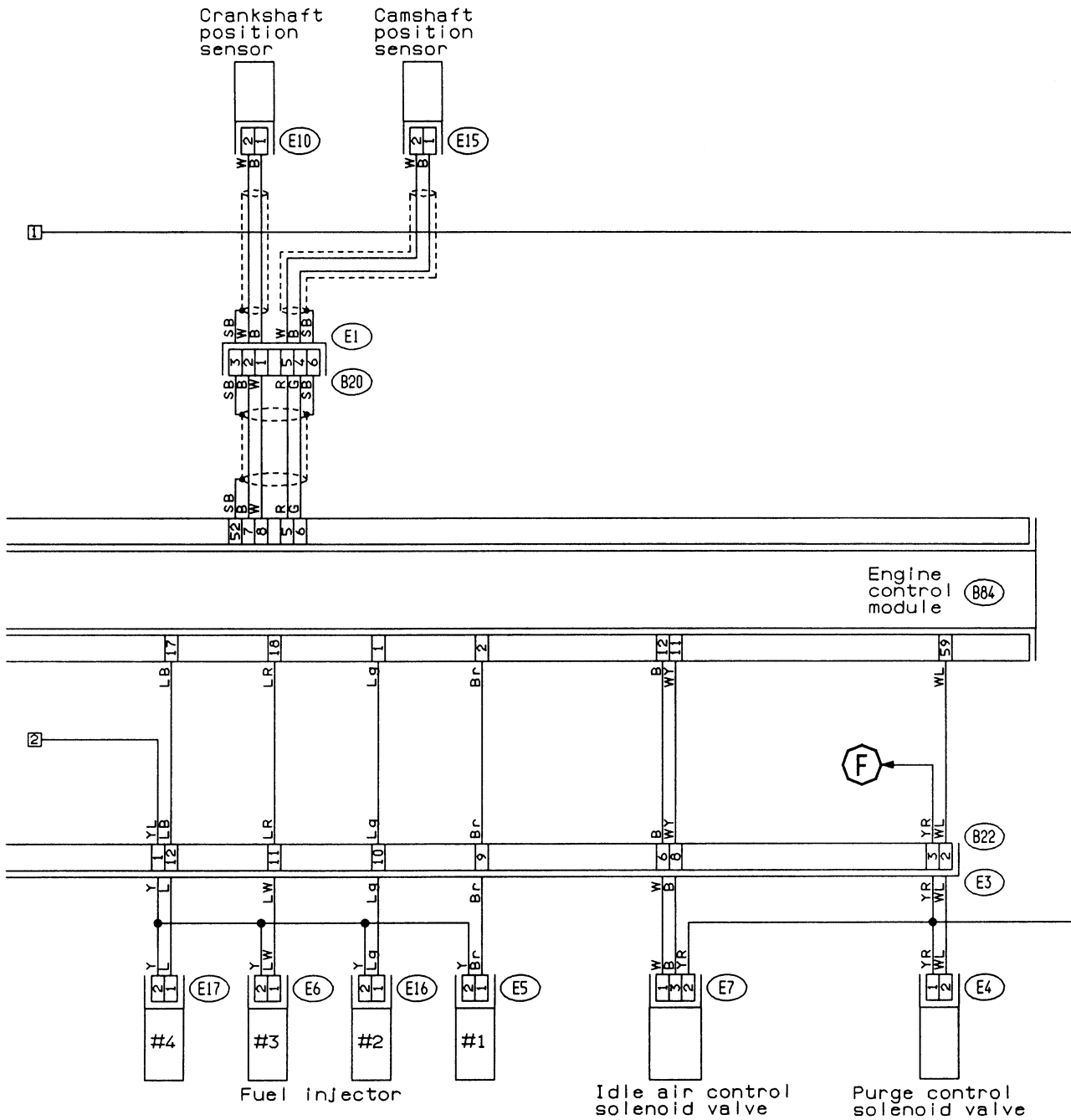

(E15) (Dark gray) (E5) (E16) (Light gray)

(E10) (Gray) (Dark gray) (E6) (E17) (Dark gray)



(B84) (Dark gray)

(E4) (Blue)

(E7) (Gray)

(B20) (Light gray)



1	2	3	4	5	6	7	8	9	10	11	12	13	14	15	16																																				
17	18	19	20	21	22	23	24	25	26	27	28	29	30	31	32	33	34	35	36	37	38	39	40	41	42	43	44																								
45	46	47	48	49	50	51	52	53	54	55	56	57	58	59	60	61	62	63	64	65	66	67	68	69	70	71	72	73	74	75	76	77	78	79	80	81	82	83	84	85	86	87	88	89	90	91	92	93	94	95	96